

The S-7000 Eyelet /Pin insertion machine is a custom-made model for various size Eyelet or PIN automatic assembly to PCB. PC controller, servo motor drive, vision programming. SMEMA connector.



Eyelet/Pin Insertion PCB



Eyelet/Pin

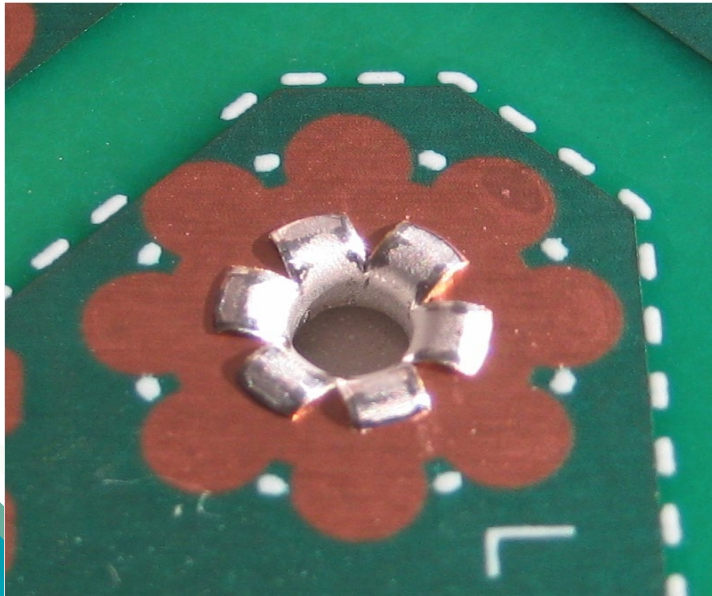

**Eyelet/Pin after
insert to PCB**

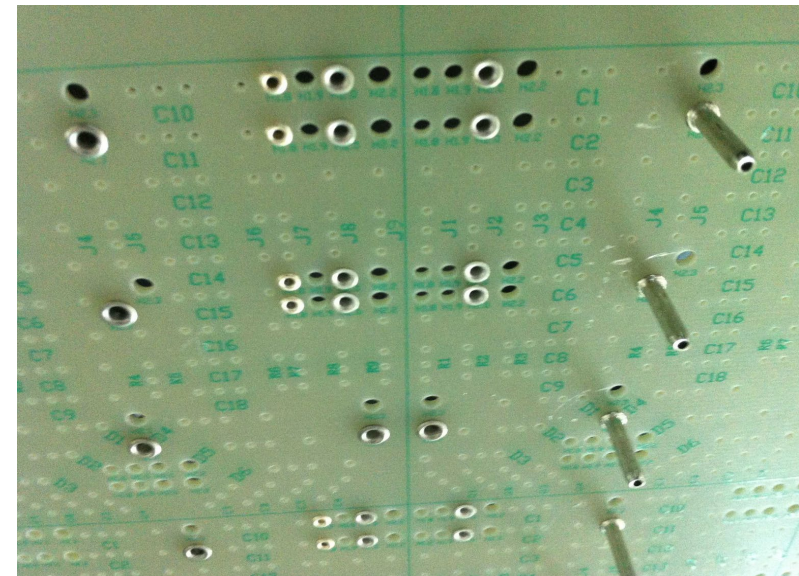

Machine Introduction

The S-7000 offers consistently high precision insertion to improve throughput, product quality and output per floor space, while reducing associated labor costs and time requirements to provide greater returns.

- Completely controlled by computer, English operation system, based on Windows ,convinent to operate, fast, simple, easy to learn.
- Use machine vision technology, on-line programming, auto correction, auto recognizing MARK point.
- Use AC servo system and optimized circuit, eliminating the unstability caused by circuit error, ensure the system is stable and rapid also power economic
- PCB auto loading

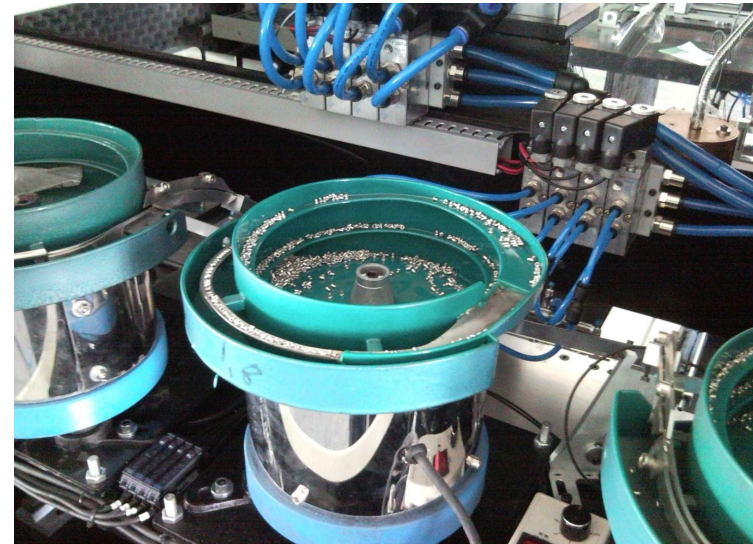

Machine in Details

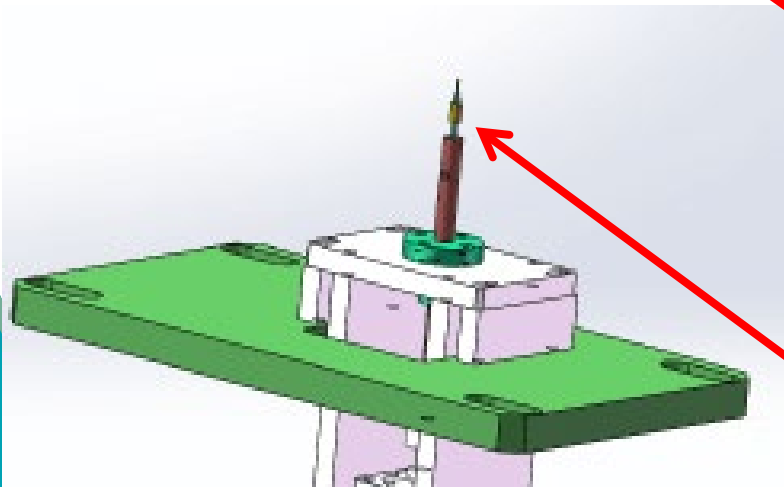
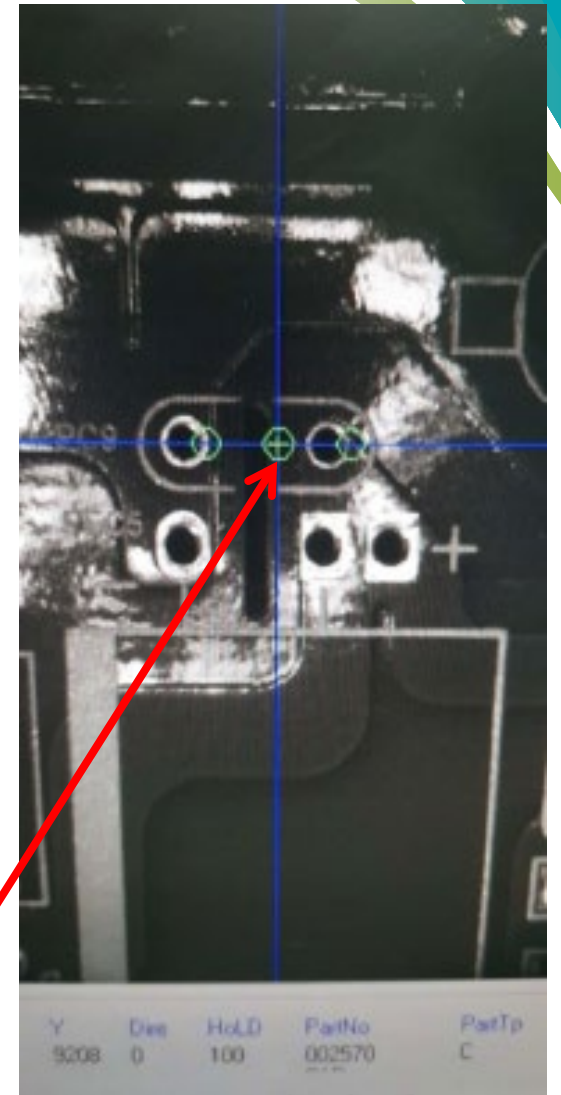
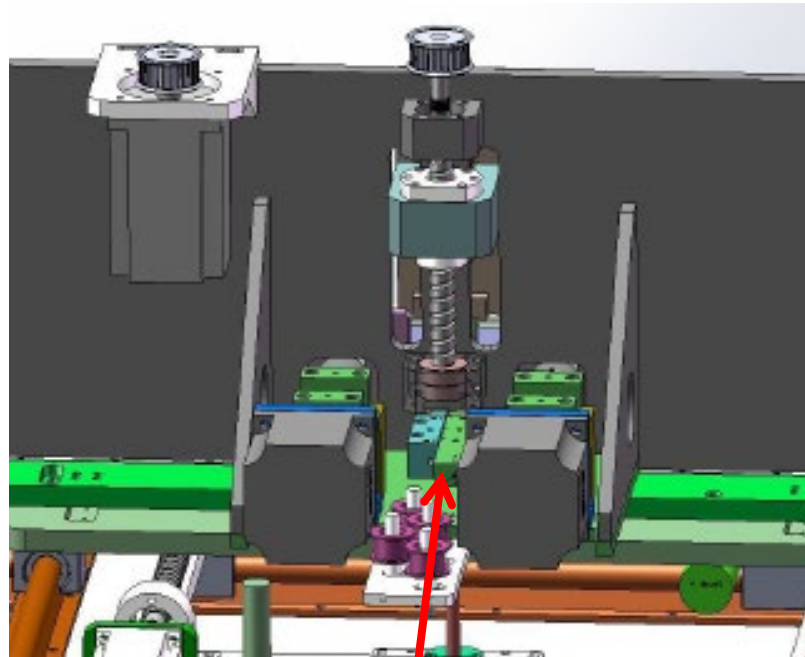
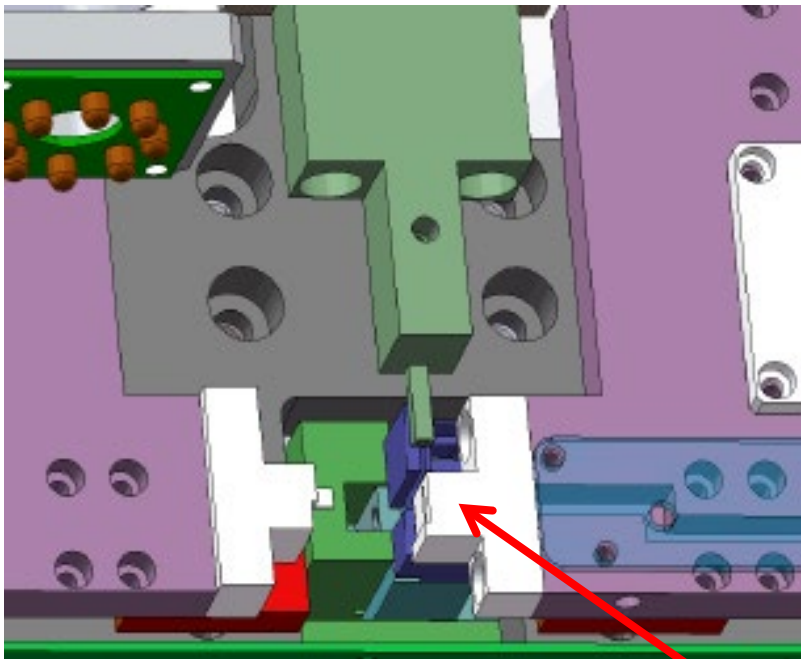

Inserion head

Feeder

Vision programming

Clinching base(PCB support& miss check)

Machine Introduction

Please click to see 3D model:
[2 Eyelet Insertion machine with Loader unloader](#)

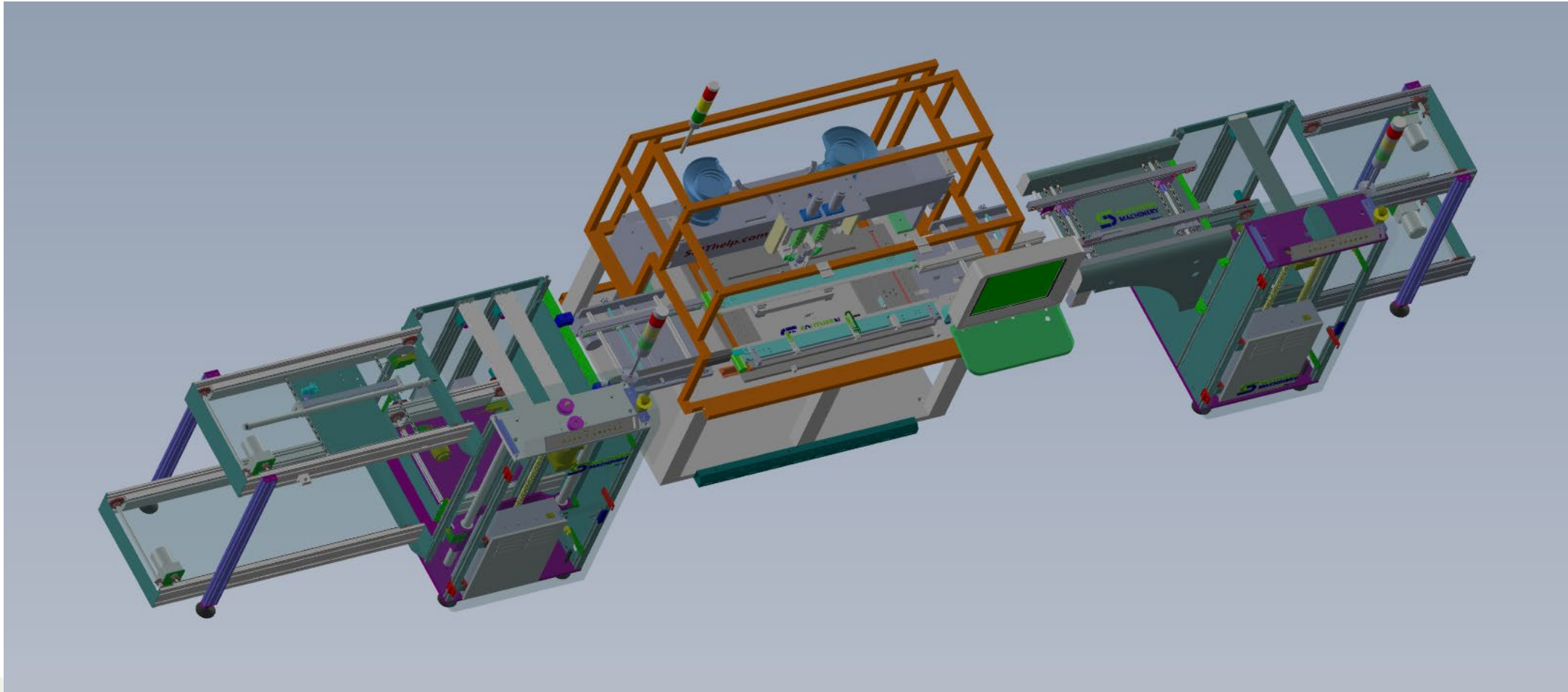

PCB Handling ASSY

X/Y Table

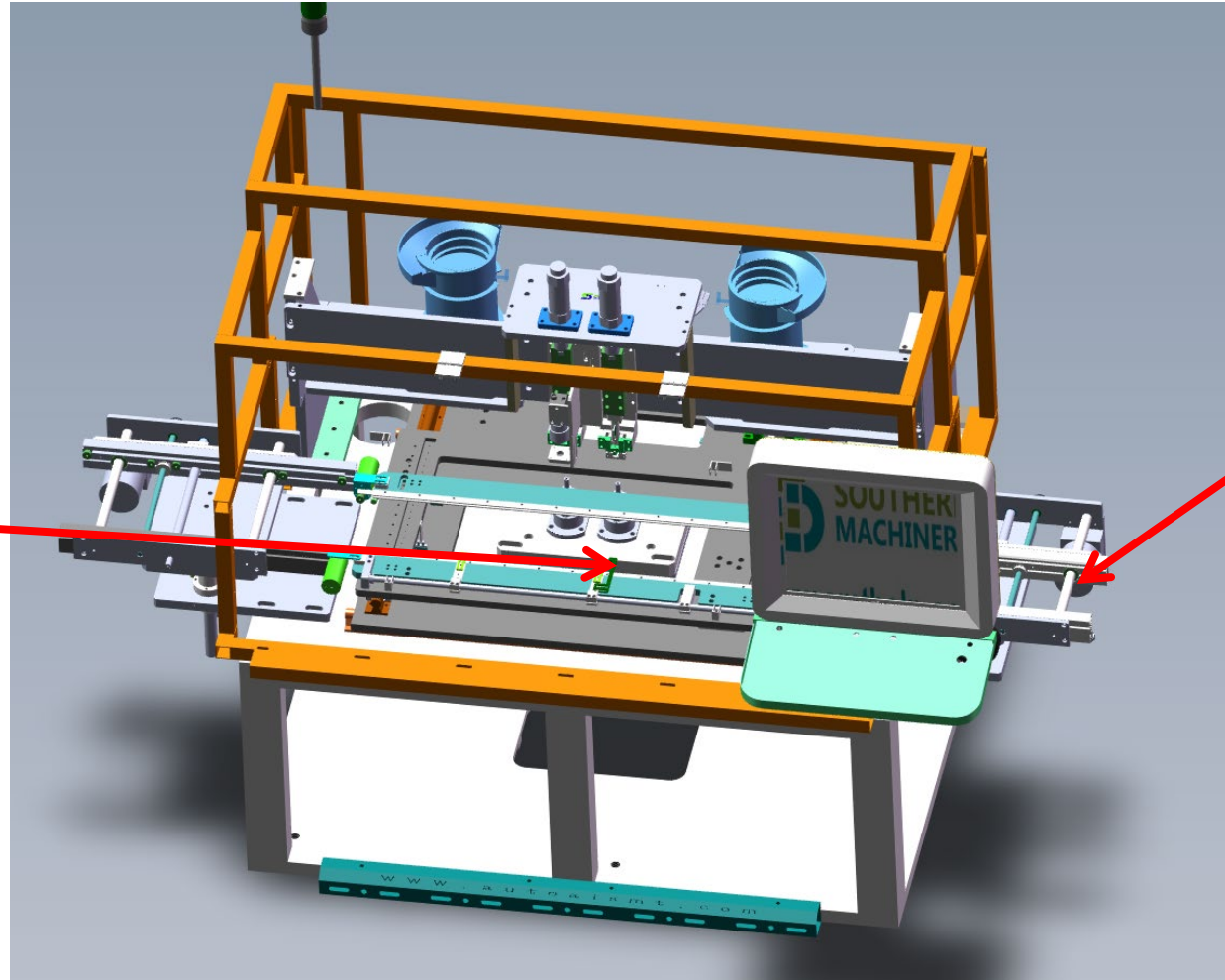

Conveyor(L to R in-line)

PCB Handling ASSY

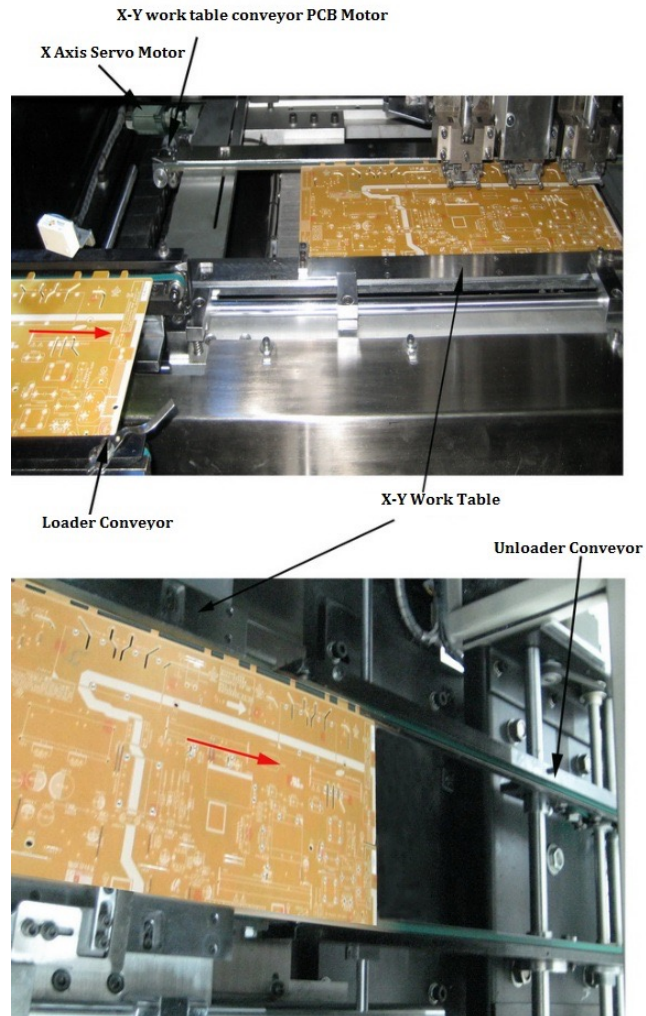

Auto PCB loading Servo X-Y working Table

1. The Loader conveyor transport the PCB to X-Y work table, X-Y servo motor to drive the X-Y work table positioning.
2. After base part of Insertion Head finish the insertion (Detection system will inspect the insertion successfully into the next step, if not finish then repeat this action), X-Y work table will transport the completed insertion PCB to Unloader conveyor.

Eyelet Feeding ASSY

Eyelet/Pin S-7000E - In Detail

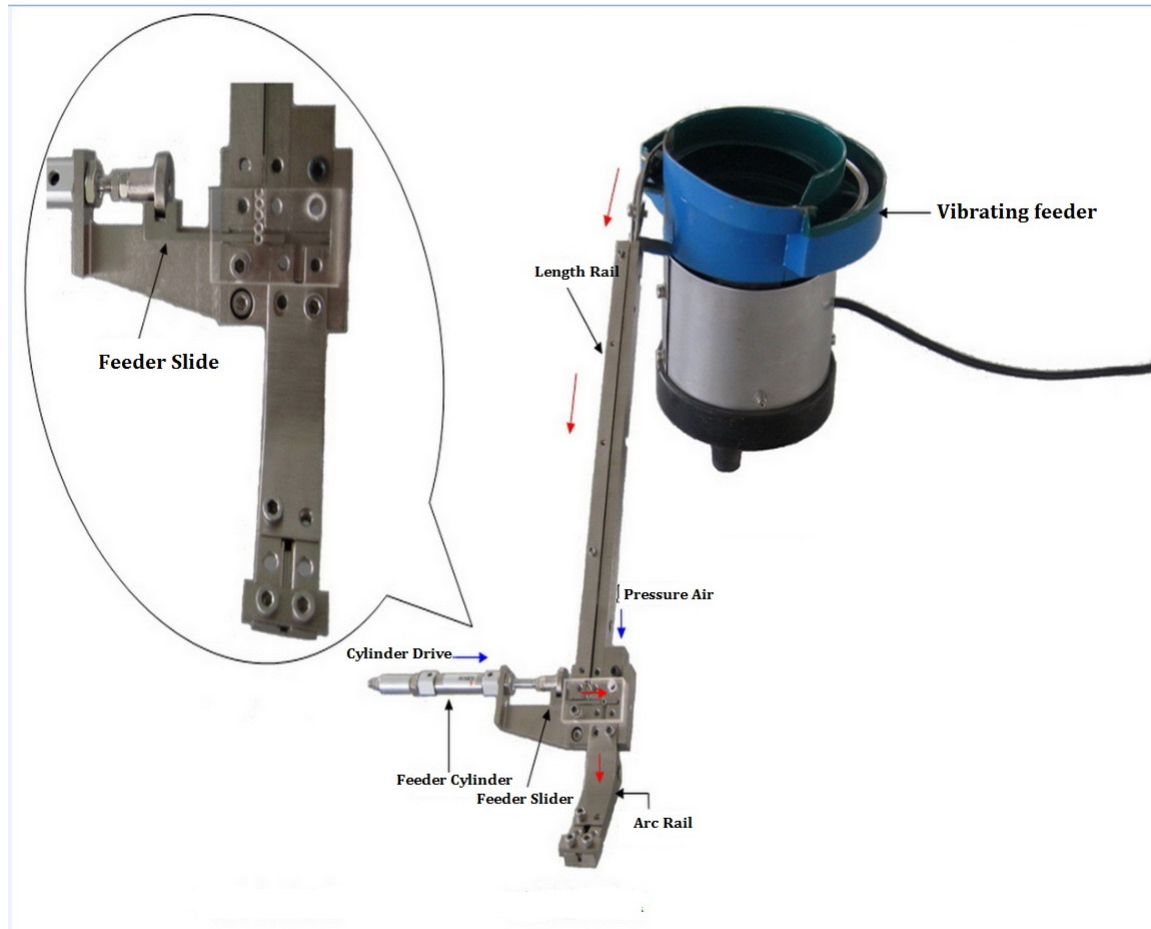

1. Vibrating feeder sequence bulk rivet/Eyelet pin to length rail.
2. Use Eyelet/Pin's weight through length rail slide down to feeder slider.
3. Feeder Cylinder drive the feeding slider to push the eyelet/pin on arc rail one by one.
4. Pressure air put eyelet/pin through arc rail and push it to the material Clip of insertion Head.

Machine Insertion Head ASSY

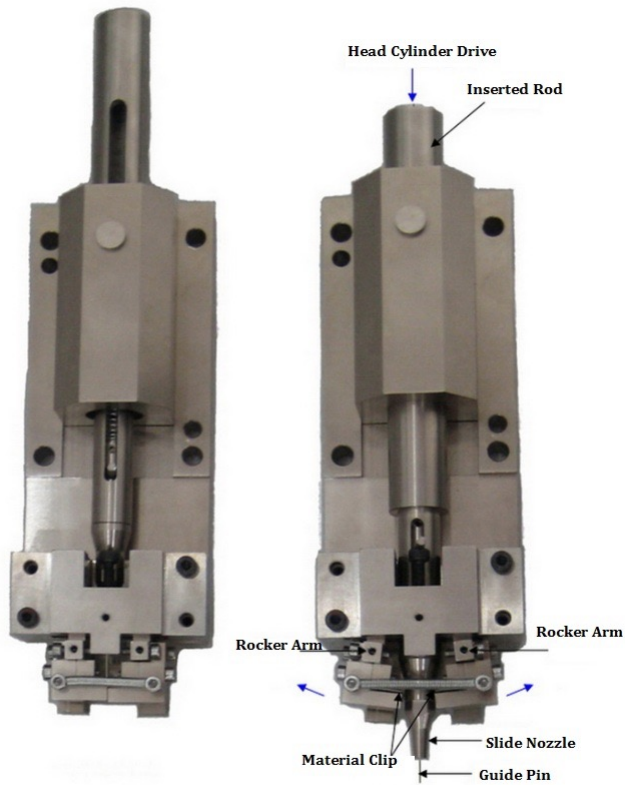

* Action Start State

* Action Finished State

Connect to motor

Head driver

Programming camera

Nozzle

R cutter

L cutter

Pedestal

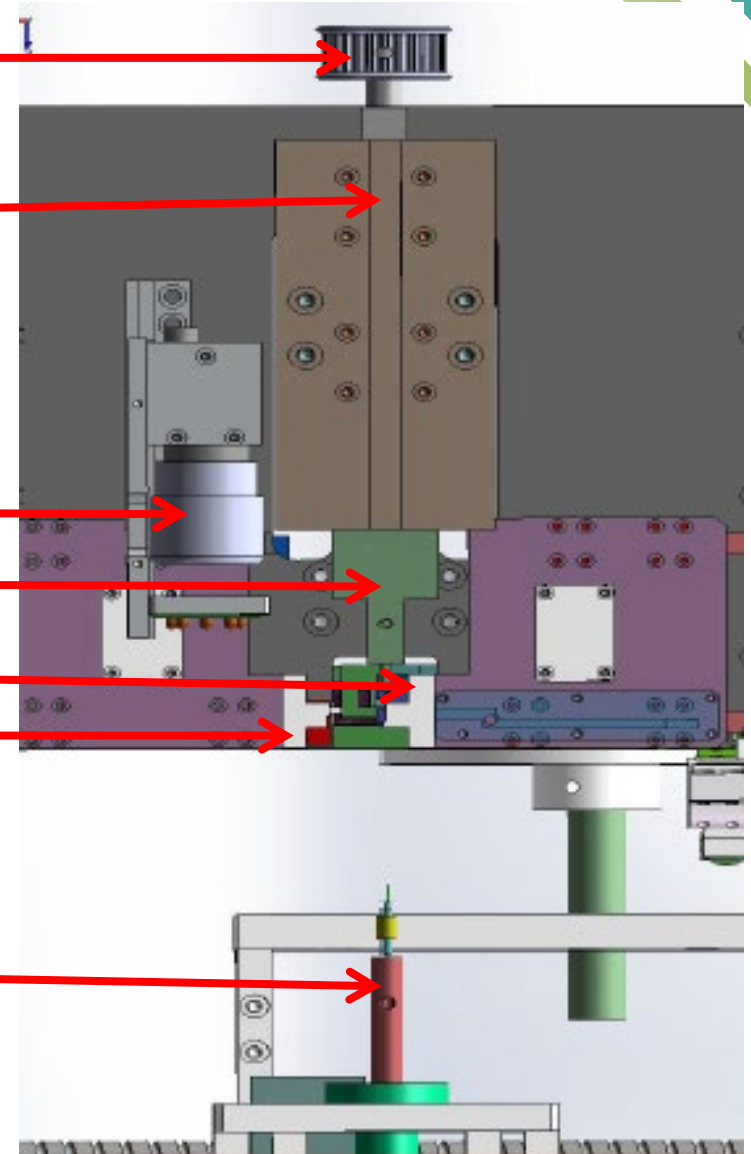

Machine Clinching base



The base cylinder to drive the base axis to up move, lower die insert to eyelet/pin bottom, the blade of lower die cutting the eyelet/pin bottom and pressing to blossom process.

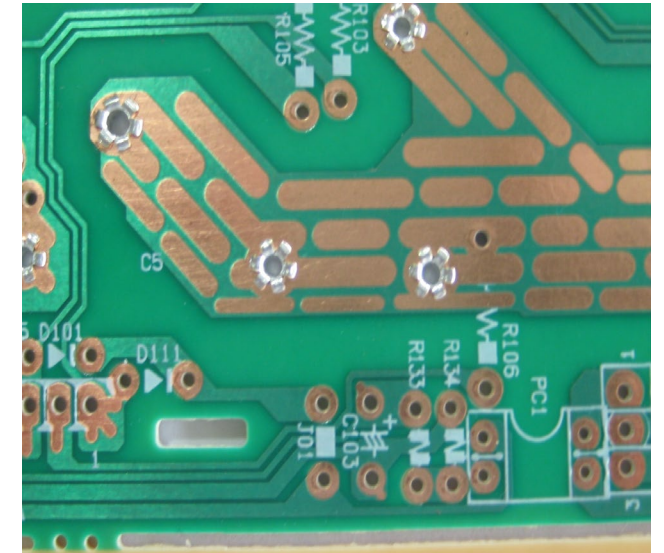
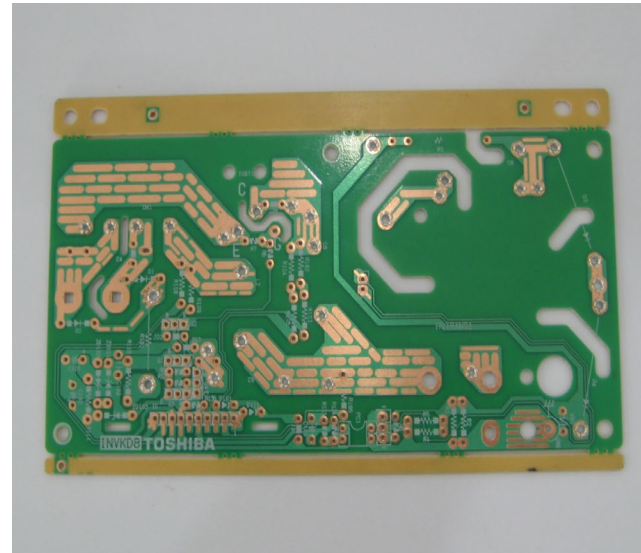

Machine Specifications

Machine size: 1450mm*1300mm*1600mm(L*W*H)

Speed: Max 4000 Component per hour

PCB size: 50*50~400*400 (mm)

PCB thickness: 0.79~2.36 mm

Power: 220V 50/60hz single phase, with UPS

Safe distance between 2 components: $\geq 2\text{mm}$

Air pressure: 0.6-0.8MPA

Drive system: AC servo, AC motor

**Insert position programming & calibration:
machine vision by 0.3M CCD**

PCB transfer : L to R / R to L(optional) in-line

Weight: 1000KG

**Others: Windows system/Data transfer USB
port/SMEMA connector**

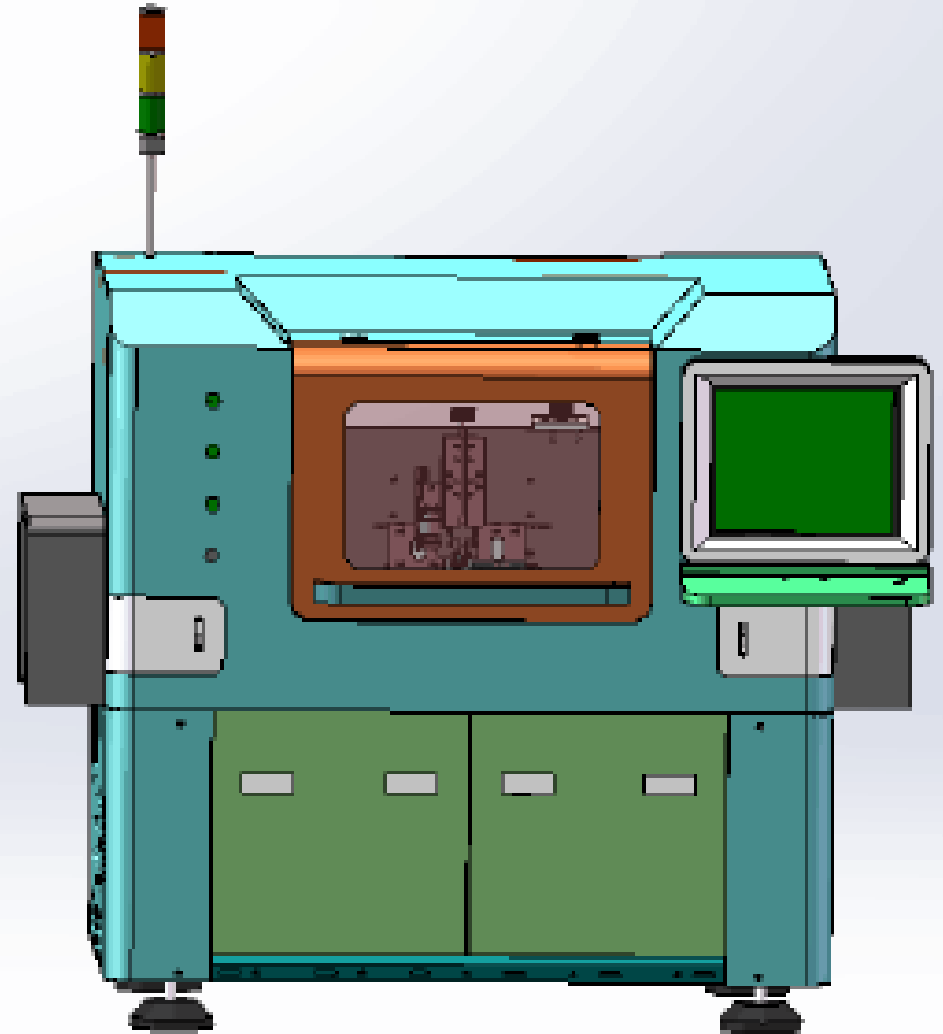

S7000 Machine working in Customer



Southern Machinery

Southern Machinery was established in Shenzhen China in March 2011. We provide professional automatic insertion machines tailor-made for your Electronic Manufacturing Factory. The Southern Machinery team has over 20 years of experience in the electronics manufacturing industry. We uphold the design philosophy of American auto insertion machines and offer the highest quality of customer service. Depending on your needs, we will conduct any level of EMS design work for you so that you can focus on the manufacturing and sale of your electronic products while we do the set-up work for you.

Our Client



Best pre-sales / after sales service support

- **Worldwide Support**
- **Free Installation/ Training**
- **1 day lead-time (spare parts)**
- **1 Month customize solution**



Please visit

www.smthelp.com

Find us more

<https://www.facebook.com/autoinsertion>

Know more our team

<https://cn.linkedin.com/in/smtsupplier>

Welcome to our factory in Shenzhen China

See more machine working video, please Youtube [Auto Insertion](#)

Google

Auto+insertion, to get more informations

Looking forward to your email

info@smthelp.com